

# Thompson OneFrame™

## Selection Guide

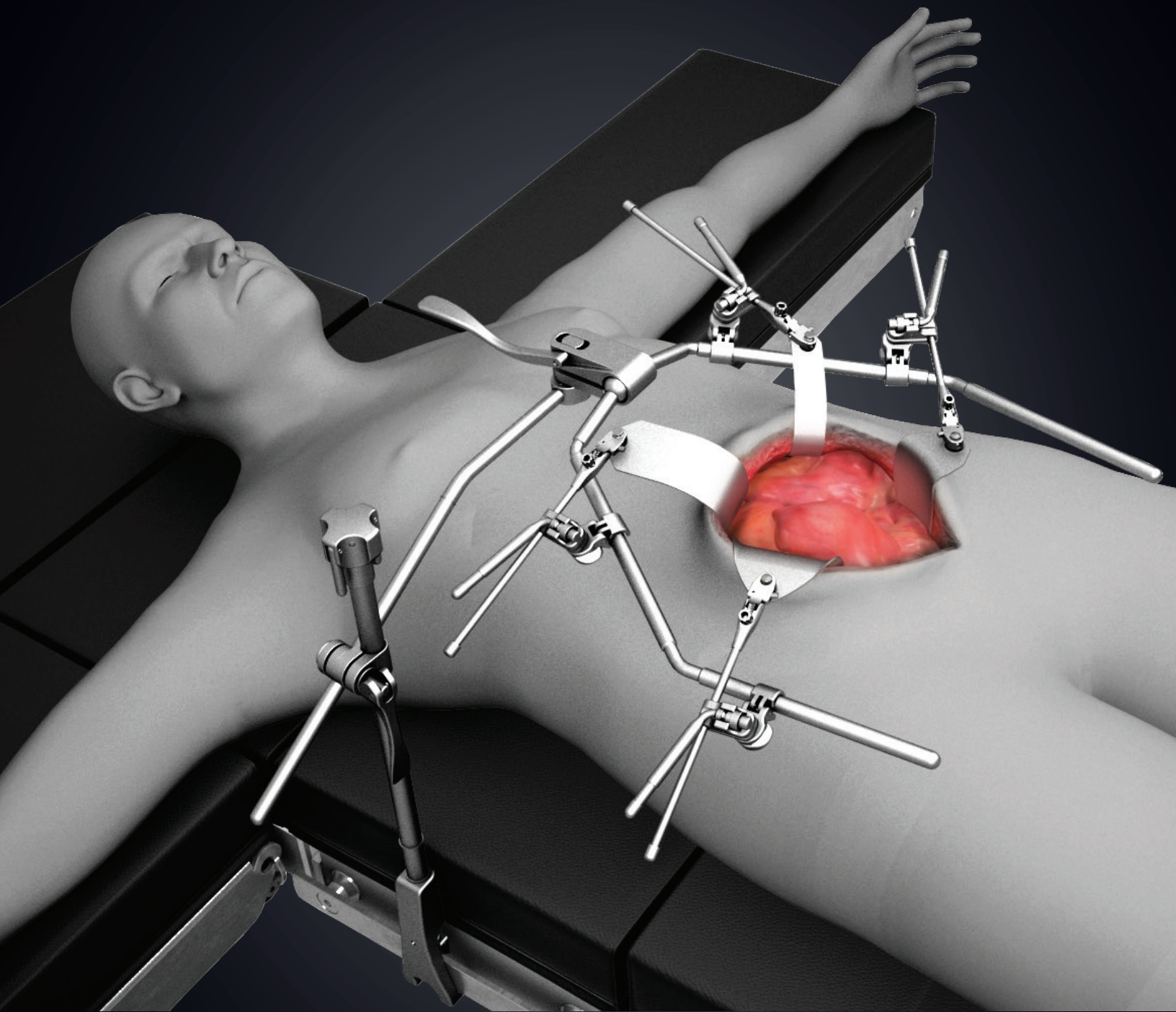

## NEW Thompson OneFrame™

Discover the OneFrame, offered as a Frame Kit and separate Blade Kits to best suit your specialty and procedures

Single piece OneFrame™ provides fast, easy set up and adjustments with Thompson's patented S-Lock® and Quick Angle features.

**Thompson Retractor Exclusive Features:** Thompson is dedicated to offering the most forward thinking, proven, and high quality features. These exclusive, often patented, features define Thompson and allow for Uncompromised Exposure.

### Elite III Rail Clamp

Our newest Elite Rail Clamp is faster and lighter than ever before. Mounts and adjusts within the sterile field.





**One Piece Frame**

Easy close joint allows for fast, simple set up.



**NEW S-Lock® Technology**

Swivel 360° or lock blade in any position. Easily switch from 'swivel' to 'locked' with the push of a button.

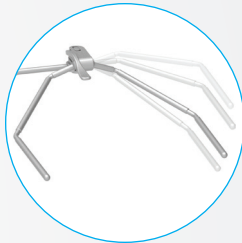

**Versatile Set Up**

Arms may be adjusted independently for maximum versatility.



**NEW Quick Angle Handles**

Blades are quickly and precisely angled in or out 45° with fingers or T-Handle.

**NEW Thompson OneFrame™**

**Fast, Easy Set Up**

Discover the OneFrame, offered as a Frame Kit and separate Blade Kits to best suit your specialty and procedures

A

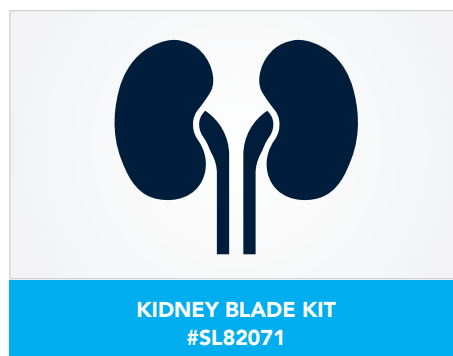
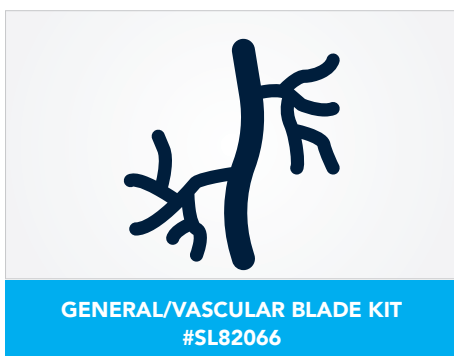
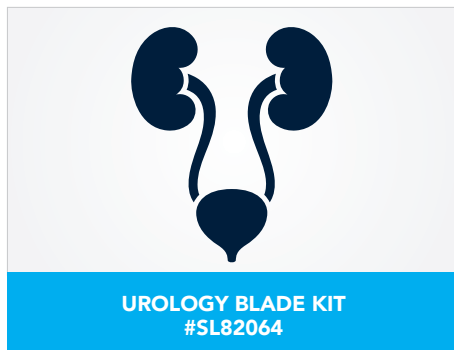
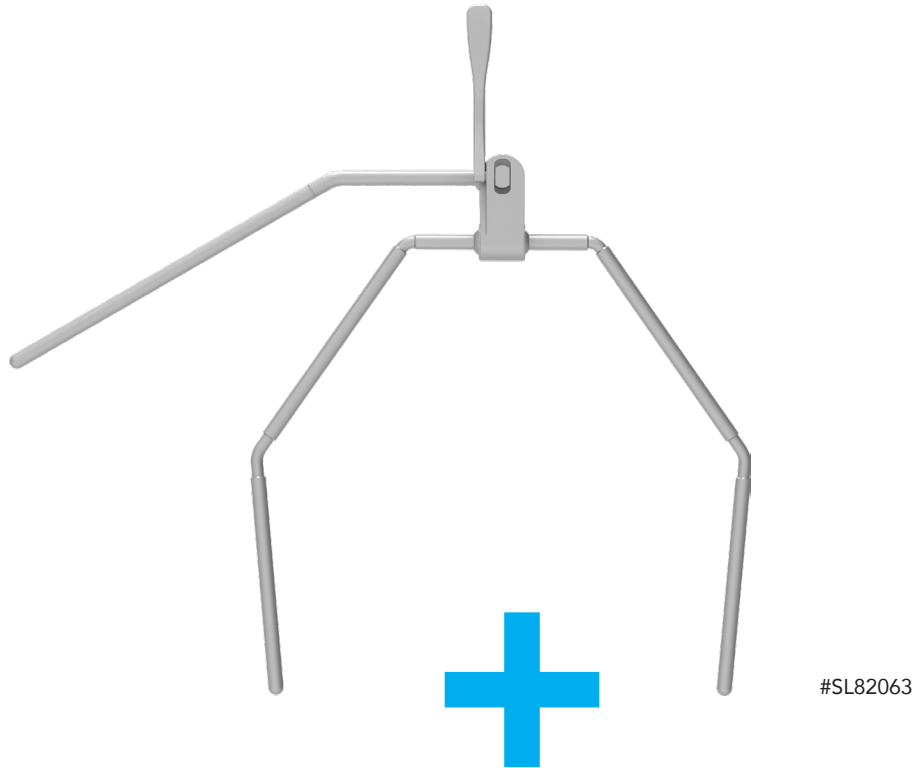

Thompson OneFrame™ COMPONENTS

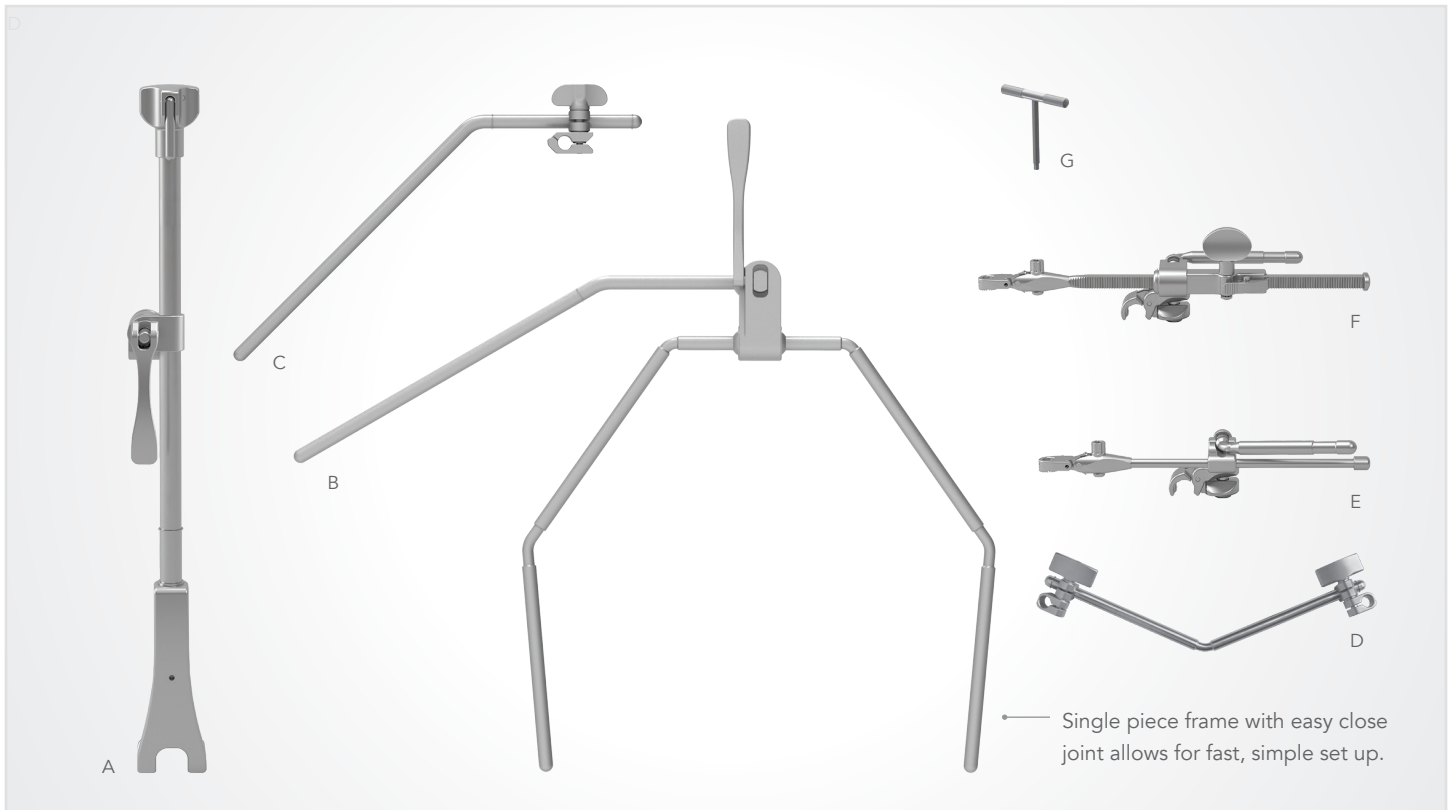

ONEFRAME™ FRAME KIT

#SL82063

REF	PART #	ITEM DESCRIPTION	QTY
A	43902AC	Elite III Rail Clamp with 1 Cam Joint 18"	1
B	47500	OneFrame™	1
C	44013H	Extension Arm 18" with Spring Hinge	1
D	44118B	Angled Closure Arm 9" x 9"	1
E	SL42126WGP	Cam II Clip-On Quick Angle 8"	5
F	SL45006CGP	Micro-Adjustable II Clip-On Quick Angle 10"	1
G	60020	T-Handle	2
H	50000G	Instrument Case 23" x 11" x 3.5"	1

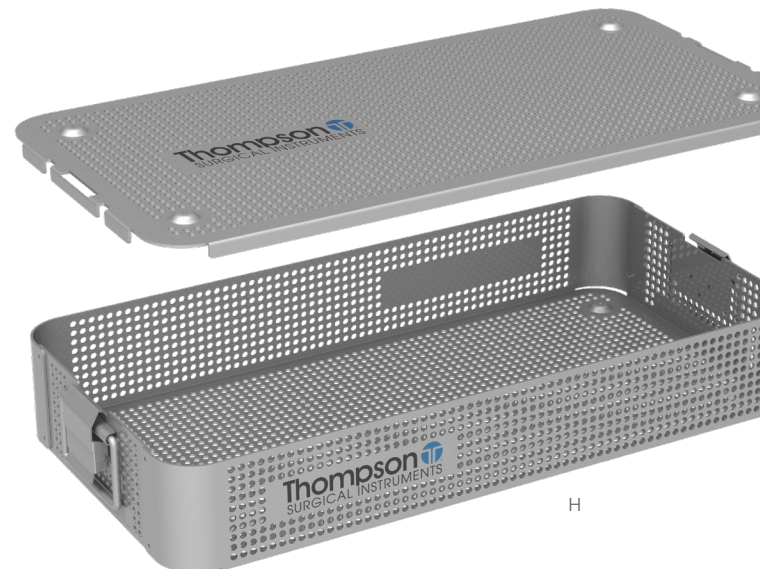

## Anterior Lumbar Blade Kit COMPONENTS

### ANTERIOR LUMBAR BLADE KIT

#SL82065

(ANTERIOR LUMBAR BLADE KIT #SL82065)

REF	PART #	ITEM DESCRIPTION	QTY
<b>Tray 1</b>			
A	SL46192ET	Reverse Lip Malleable 25mm x 200mm	2
	SL46193ET	Reverse Lip Malleable 32mm x 200mm	2
B	SL46260RET	Reverse Lip 25mm x 100mm	2
	SL46261RET	Reverse Lip 25mm x 110mm	2
	SL46262RET	Reverse Lip 25mm x 120mm	2
	SL46263RET	Reverse Lip 25mm x 130mm	2
	SL46265RET	Reverse Lip 25mm x 150 mm	2
	SL46267RET	Reverse Lip 25mm x 170mm	2
	SL46269RET	Reverse Lip 25mm x 190mm	2
	SL46271RET	Reverse Lip 25mm x 210mm	2
	SL46273RET	Reverse Lip 25mm x 230mm	2
	SL46275RET	Reverse Lip 25mm x 250mm	2
	SL46280RET	Reverse Lip 32mm x 100mm	2
	SL46282RET	Reverse Lip 32mm x 120mm	2
	SL46284RET	Reverse Lip 32mm x 140mm	2
	SL46286RET	Reverse Lip 32mm x 160mm	2
	SL46288RET	Reverse Lip 32mm x 180mm	2
	SL46290RET	Reverse Lip 32mm x 200mm	2
	SL46292RET	Reverse Lip 32mm x 220mm	2
	SL46293RET	Reverse Lip 32mm x 230mm	2
	SL46294RET	Reverse Lip 32mm x 240mm	2
	SL46295RET	Reverse Lip 32mm x 250mm	2
C	SL46260TET	Reverse Lip Tapered 25mm x 100mm	2
	SL46265TET	Reverse Lip Tapered 25mm x m150mm	2
	SL46270TET	Reverse Lip Tapered 25mm x 200mm	2
D	SL46119BET	Radiolucent Malleable Concave Round Neck Renal 25mm x 140mm	2
E	SL46119CET	Radiolucent Malleable Concave Round Neck Renal 25mm x 190mm	2
	SL46564	Radiolucent Concave Short Neck Renal 25mm x 140mm	4
	SL46569	Radiolucent Concave Short Neck Renal 25mm x 190mm	4
	SL46575	Radiolucent Concave Short Neck Renal 25mm x 250mm	4
F	51234	Suction w/Sals Tip Stylet	1
G	51236	Al Depth Gauge 335mm	1
	50000ERL	Case - Expanded Reverse Lip	1

REF	PART #	ITEM DESCRIPTION	QTY
<b>Tray 2</b>			
	SL46558	Radiolucent Concave Short Neck Renal 25mm x 80mm	4
H	SL46560	Radiolucent Concave Short Neck Renal 25mm x 100mm	4
	SL46562	Radiolucent Concave Short Neck Renal 25mm x 120mm	4
I	SL46564	Radiolucent Concave Short Neck Renal 25mm x 140mm	4
	SL46566	Radiolucent Concave Short Neck Renal 25mm x 160mm	4
J	SL46568	Radiolucent Concave Short Neck Renal 25mm x 180mm	4
	SL46570	Radiolucent Concave Short Neck Renal 25mm x 200mm	4
	50000ALR	Case - AL Renal Vein (Blades)	1
<b>Tray 3</b>			
	SL46119BET	Radiolucent Malleable Concave Round Neck Renal 25mm x 140mm	2
	SL46119CET	Radiolucent Malleable Concave Round Neck Renal 25mm x 190mm	2
	SL46119RET	Radiolucent Long Neck Renal 25mm x 140mm	2
	SL46120RET	Radiolucent Long Neck Renal 25mm x 190mm	2
	SL46121RET	Radiolucent Long Neck Renal 25mm x 255mm	2
K	SL46122ET	Radiolucent Malleable 51mm x 203mm	2
L	SL46140ET	Radiolucent Balfour 65mm x 72mm	2
	SL46141ET	Radiolucent Balfour 83mm x 70mm	1
M	SL46145ET	Radiolucent Splanchnich 51mm x 115mm	1
N	SL46160ET	Radiolucent Harrington 64mm x 152mm	1
	SL46176ET	Radiolucent Deaver 76mm x 127mm	1
	51234	Suction for AL Surgery with SALS Tip Stylet	1
O	60021	Hex Tool 3/16" with T-Handle	1
P	SL42126WDP	Cam II Clip-On Dual Angle 8"	2
	50000ALTI	Case - Anterior Lumbar Insert	1
Q	SL42128G	S-Lock QA Handheld Adapter	1
	50000G	Instrument Case 23" x 11" x 3.5"	1

Anterior Lumbar Blade Kit COMPONENTS

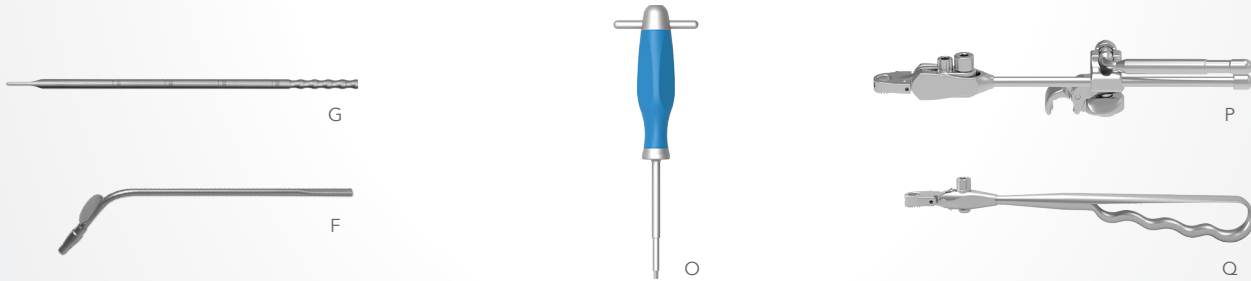
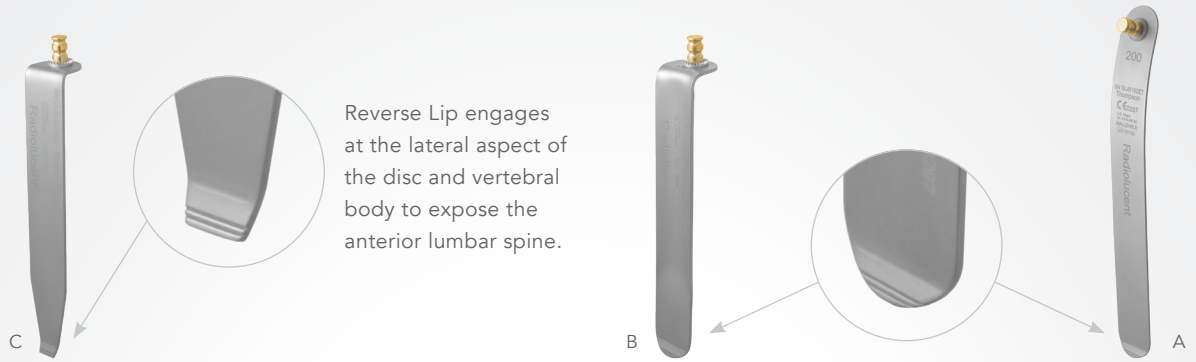

## General/Vascular Blade Kit COMPONENTS



### GENERAL/VASCULAR BLADE KIT

#SL82066

(GENERAL/VASCULAR BLADE KIT #SL82066)

REF	PART #	ITEM DESCRIPTION	QTY
A	SL46118	Malleable 25mm x 203mm	1
	SL46122	Malleable 51mm x 203mm	2
	SL46124	Malleable 64mm x 254mm	1
	SO46124A	Malleable 76mm x 254mm	1
B	SL46119B	Concave Round Neck Renal 25mm x 140mm	2
	SL46119C	Concave Round Neck Renal 25mm x 190mm	2
C	SL46122V	Malleable Slotted 51mm x 203mm	1
	SO46124AV	Malleable Slotted 76mm x 203mm	1
D	SL46125	Richardson 19mm x 25mm	1
	SL46151	Richardson 51mm x 127mm	2
E	SO46129	Kelly 64mm x 76mm	2
	SO46130	Kelly 76mm x 89mm	1
F	SO46134	Fence 102mm x 102mm	1
	SO46135	Fence 102mm x 127mm	1
	SO46136	Fence 102mm x 152mm	1
G	SO46140	Balfour 70mm x 73mm	1

REF	PART #	ITEM DESCRIPTION	QTY
	SO46141	Balfour 83mm x 73mm	1
H	SO46140C	Balfour Small Lip 66mm x 73mm	2
	SO46141C	Balfour Small Lip 78mm x 73mm	1
I	SL46143	Fenestrated 44mm x 89mm	2
	SL46144	Fenestrated 48mm x 127mm	2
J	SL46145	Splanchnich 51mm x 114mm	1
	SL46146	Splanchnich 51mm x 152mm	1
K	SL46160	Harrington 64mm x 152mm	1
L	SL46174	Deaver 51mm x 127mm (2" x 5")	1
	SO46176	Deaver 76mm x 127mm (3" x 5")	1
M	SO46188	St Marks with Lip 64mm x 178mm	1
N	SL46191	Malleable Finger 6in	1
O	SO46241A	Balfour 83mm x 57mm	1
P	SO46241B	Balfour 100mm x 61mm	1
Q	SO46241C	Balfour 114mm x 63mm	1
	50000G	Instrument Case 23 x 11 x 3.5in	1



## Urology Blade Kit COMPONENTS

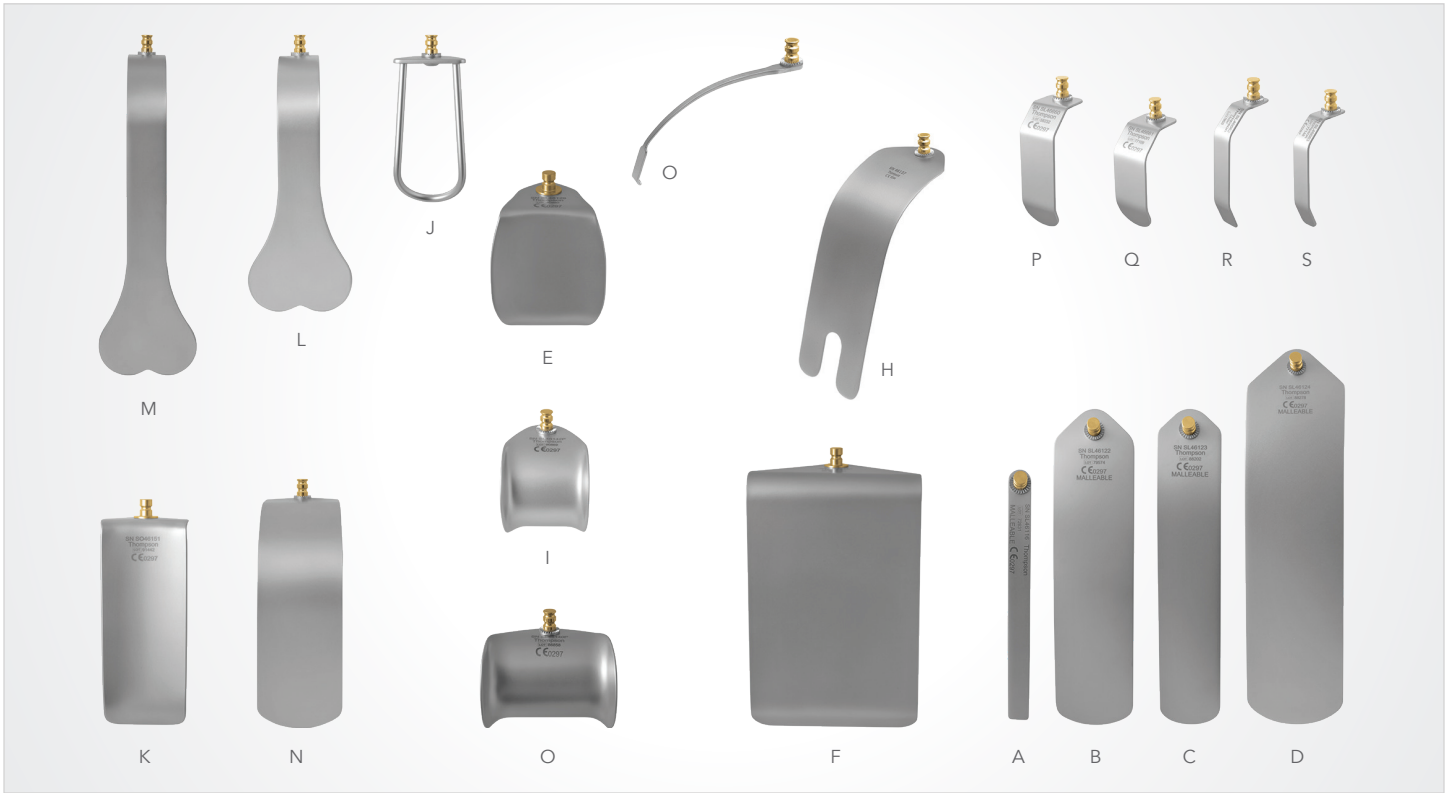

### UROLOGY BLADE KIT

#SL82064

(UROLOGY BLADE KIT #SL82064)

REF	PART #	ITEM DESCRIPTION	QTY
A	SL46116	Malleable 13mm x 152mm	1
B	SL46122	Malleable 51mm x 203mm	1
C	SL46123	Malleable 38mm x 203mm	1
D	SL46124	Malleable 64mm x 254mm	1
E	SO46129	Kelly 64mm x 76mm	1
F	SO46136	Fence 102mm x 152mm	1
H	SL46137	Holtgrewe 60mm x 152mm	1
I	SL46140P	Balfour 76mm x 51mm	2
	SL46142P	Balfour 51mm x 54mm	2
J	SL46143	Fenestrated 44mm x 89mm	2
K	SO46151	Richardson 51mm x 127mm	1

REF	PART #	ITEM DESCRIPTION	QTY
L	SL46160	Harrington 64mm x 152mm	1
M	SL46163	Harrington 64mm x 203mm	1
N	SL46174	Deaver 51mm x 127mm (2" x 5")	1
O	SL45753AM	Prostate Retractor 8mm	1
P	SL46660	Double Angled 25x76mm	2
Q	SL46661	Double Angled 25x64mm	2
R	SL46662	Double Angled 13x76mm	2
S	SL46663	Double Angled 13x70mm	2
	SL46215	Murphy Blunt 4 Png 25x13mm	1
	50000G	Instrument Case 23 x 11 x 3.5in	1

## Kidney Blade Kit COMPONENTS

### KIDNEY BLADE KIT

#SL82071

( KIDNEY BLADE KIT #SL82071 )

REF	PART #	ITEM DESCRIPTION	QTY
	SL46118	Malleable 25mm x 203mm (1" x 8")	2
A	SL46118A	Malleable 25mm x 254mm (1" x 10")	1
	SL46118B	Malleable 38mm x 254mm (1 ½" x 10")	1
	SL46122	Malleable 51mm x 203mm (2" x 8")	2
	SL46123	Malleable 38mm x 203mm (1 ½" x 8")	1
	SL46124	Malleable 64mm x 254mm (2 ½" x 10")	2
B	SO46124A	Malleable 76mm x 254mm (3" x 10")	2
C	SL46119B	Concave Round Neck Renal 25mm x 140mm (1" x 5 ½")	1
	SL46119C	Concave Round Neck Renal 25mm x 191mm (1" x 7 ½")	1
D	SL46127	Kelly 38mm x 51mm (1 ½" x 2")	1
	SL46128	Kelly 51mm x 64mm (1 ½" x 2 ½")	1
	SO46129	Kelly 64mm x 76mm (2 ½" x 3")	1
E	SL46140P	Balfour 76mm x 51mm (3" x 2")	2
F	SL46142P	Balfour 51mm x 54mm (2" x 2")	2
G	SL46125	Richardson 19mm x 25mm (¾" x 1")	1
H	SL46125A	Richardson 19mm x 51mm (¾" x 2")	1
I	SL46126	Richardson 25mm x 32mm (1" x "1 ¼")	1
	SL46150	Richardson 51mm x 102mm (2" x 4")	1
	SO46151	Richardson 51mm x 127mm (2" x 5")	1
J	SL46154	Richardson 51mm x 76mm (2" x 3")	1
K	SL46155	Mini Open Richardson 51mm x 76mm (2" x 3")	1
L	SL46156	Mini Open Richardson 51mm x 102mm (2" x 4")	1
M	SL46157	Mini Open Richardson 51mm x 127mm (2" x 5")	1
N	SL46158	Mini Open Richardson 51mm x 152mm (2" x 6")	1
O	SL46160	Harrington 64mm x 152mm (2 ½" x 6")	1
	SL46162P	Harrington 38mm x 127mm (1 ½" x 5")	1
	SL46163	Harrington 64mm x 203mm (2 ½" x 8")	1

REF	PART #	ITEM DESCRIPTION	QTY
	SL46165	Harrington 64mm x 102mm (2 ½" x 4")	1
P	SL46220	Mini-Open Malleable 25mm x 75mm (1" x 3")	1
Q	SL46221	Mini-Open Malleable 25mm x 100mm (1" x 4")	1
R	SL46222	Mini-Open Malleable 25mm x 125mm (1" x 5")	1
S	SL46224	Mini-Open Double Angled 51mm x 127mm (2" x 5")	1
T	SL46225	Mini-Open Double Angled 51mm x 152mm (2" x 6")	1
U	SL46226	Mini-Open Double Angled 51mm x 165mm (2" x 6 ½")	1
V	SL46227	Mini Open Deep Double Angled 51mm x 127mm (2" x 5")	1
W	SL46660	Double Angled 25mm x 76mm (1" x 3")	1
	50000G	Instrument Case 23" x 11" x 3 ½"	1

## Kidney Blade Kit COMPONENTS

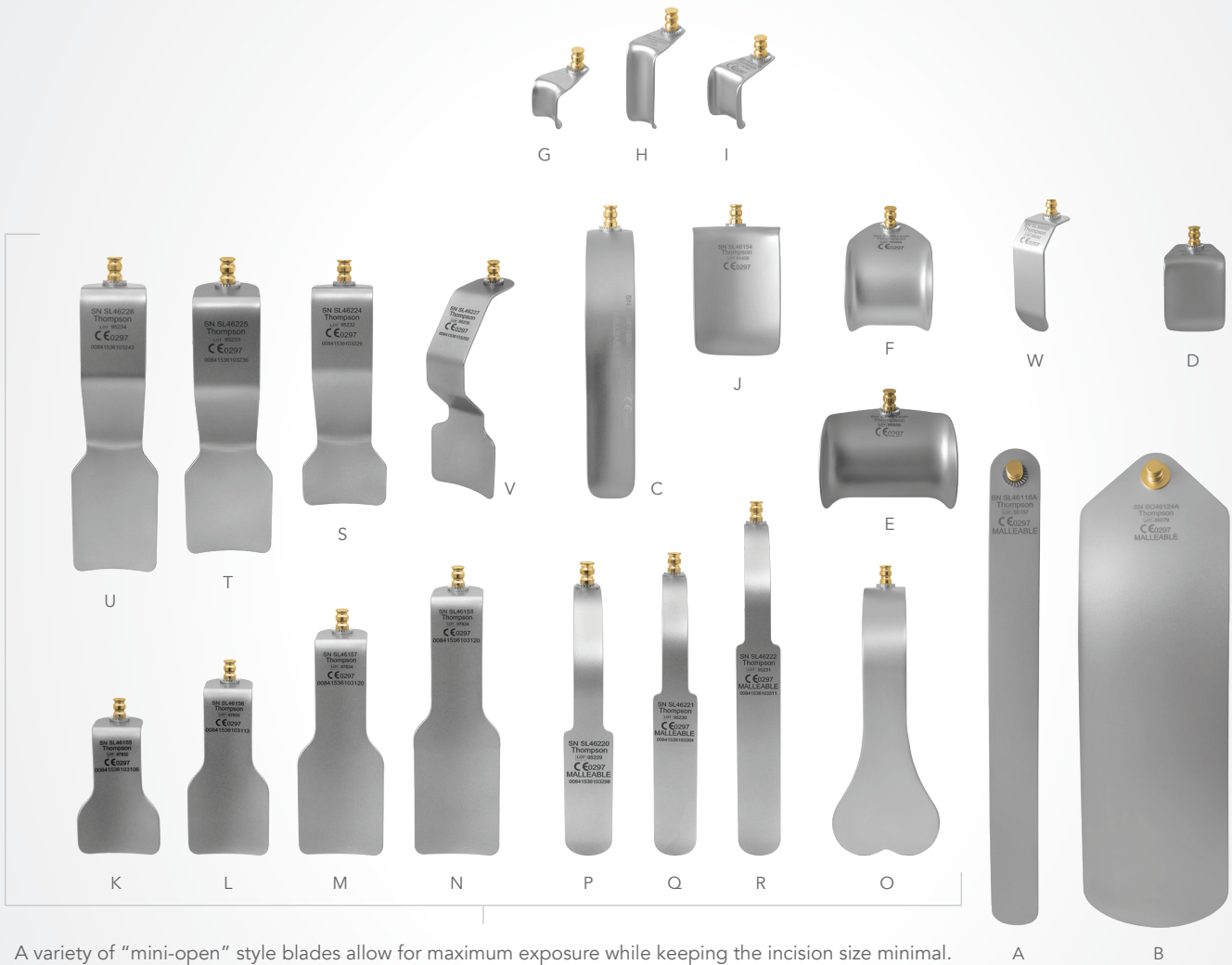



Uncompromised Exposure™

VISIT US ONLINE: [THOMPSONRETRACTOR.COM](http://THOMPSONRETRACTOR.COM)

## CONTACT

### Address

**Thompson Surgical Instruments, Inc.**  
10341 E Cherry Bend Rd.  
Traverse City, MI 49684  
USA

### Phone + Fax

**Toll Free** 1-800-227-7543  
**Phone** 231-922-0177  
**Fax** 231-922-0174

### Online

**Email** [contact@thompsonsurgical.com](mailto:contact@thompsonsurgical.com)  
**Website** [www.thompsonretractor.com](http://www.thompsonretractor.com)

### Social



**Thompson**  
SURGICAL INSTRUMENTS

Made In  
**USA**

\* Free trial valid for U.S. customers only. Customers outside the U.S.A., please call +1-231-922-0177 for availability.

© 2024 Thompson Surgical Instruments, Inc.

© S-Lock®, PLA®, and the "T Circle" logomark are Registered Trademarks of Thompson Surgical Instruments, Inc.  
Patents: [trpat.com](http://trpat.com).

Note: As we continually strive to provide the best products possible, some of the images in this document may appear slightly different from the product received.