

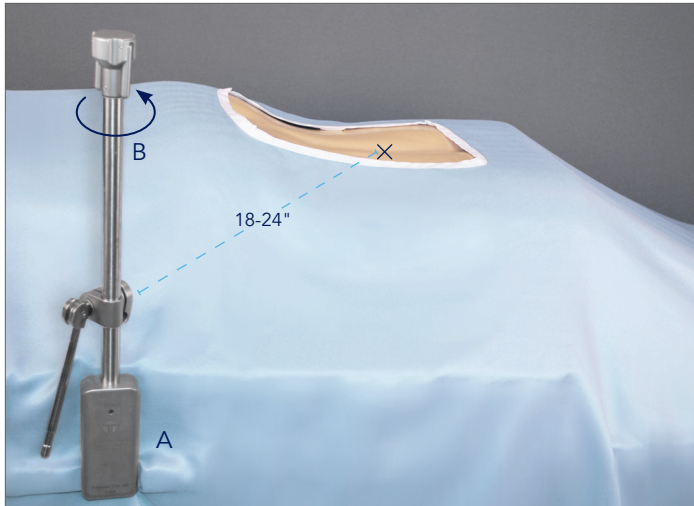

INTENDED USE: The PLA retractor system is intended for posterior lumbar exposure for procedures such as: Transforaminal Lumbar Interbody Fusion, Posterior Lumbar Interbody Fusion, Decompression, and Pedicle Screw Fixation applications. The system allows spine surgeons to accomplish minimal access with maximum visualization, by utilizing a versatile frame platform and providing flexible, independent retraction and angling from all directions while also allowing for controlled and stable exposure.

Prior to use, inspect all parts for damage: **DO NOT** use if any part has been deformed, altered, or damaged in any way.

TABLE MOUNT:



STEP 1

A Attach the Elite II Rail Clamp jaw to the table rail 18-24" away from the site of operation on either side of the table over the sterile drape.

B To secure, turn the knob at the top of the rail clamp and utilize the attached hanging handles for added leverage when needed.

TIP Position so that the rail clamp will not interfere with imaging equipment.

CAUTION If patient is obese, avoid compressing patient's body. When necessary, use a wider OR table or add to the width of the table using Rail Extender (41917).

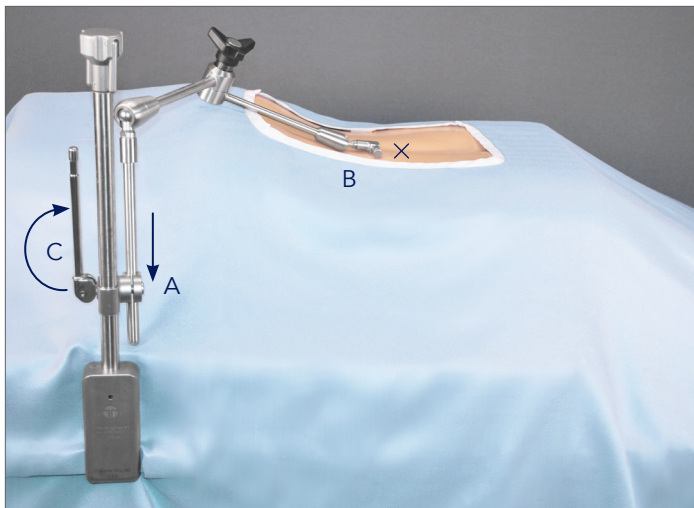

STEP 2

A Insert the Articulating Arm into the rail clamp joint.

B Ensure the distal end of the arm can reach the site of operation with several inches of flexibility.

C Rotate the arm out of the working area until ready to be used and lock to the rail clamp by flipping the rail clamp joint handle to the "locked" position, grasping the rail clamp for leverage.

TIP If a larger range of motion is needed, move the rail clamp closer to operation site. If arm is too close, move the rail clamp farther from the operation site.

SEQUENTIAL DILATION:

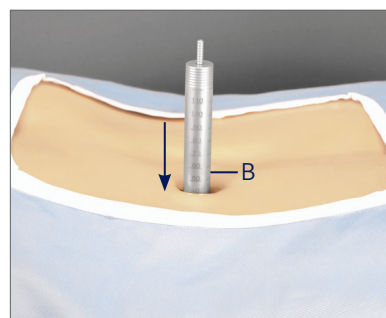
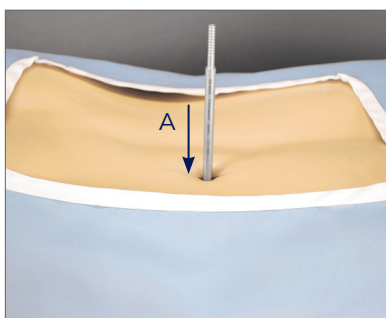

STEP 3

A After the incision is made, insert the first dilator and sequentially add the next three dilators.

B Take note of the depth marked on the dilator that is closest to the skin for blade length selection.

TIP Use caution holding dilators to avoid dropping. Do not use dilators if they are deformed or dented.

ASSEMBLE THE MIS SPINE FRAME:

STEP 4

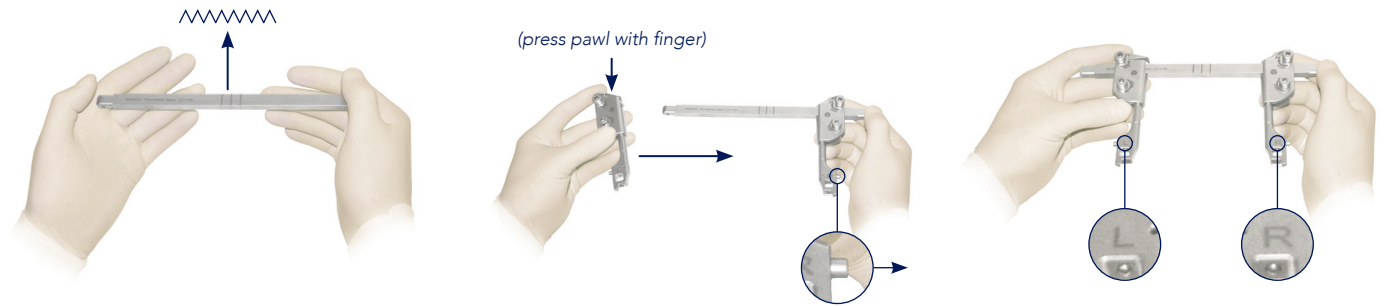

A Assemble the frame beginning by holding the rack with the toothed side facing away.

B Slide the Left and Right Frame Arms on to the rack so that the buttons are pointing outward.

C The left arm should be on the assembler's left and the right arm should be on the assembler's right.

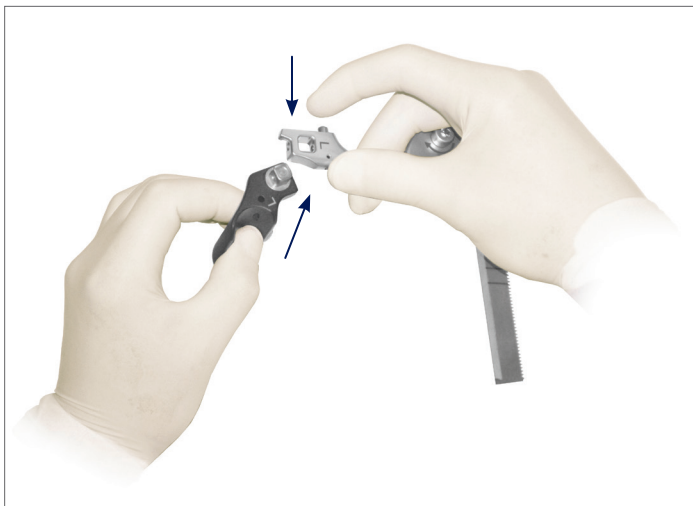

STEP 5

A Select the Left and Right Caudal/Cephalad (C/C) Blade that corresponds with the depth noted in Step 3. Attach the blade marked "L" to the left frame arm by pressing the button on the arm and inserting the blade nipple into the arm, then releasing button to secure connection.

B Repeat steps to attach the blade marked "R" to the right arm.

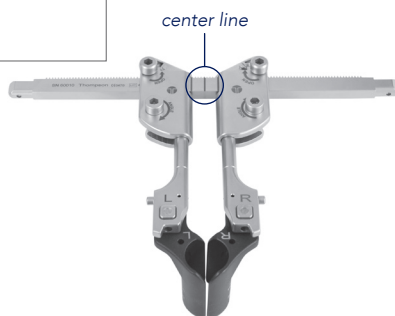
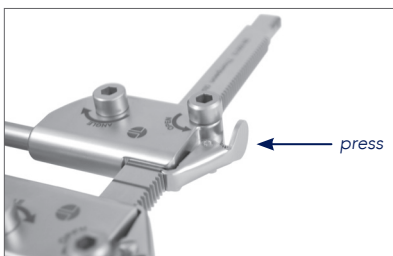

STEP 6

Press down the pawls located on each frame arm near the rack to slide the frame arms together. Center the arms on the rack for maximum retraction potential.

TIP Ensure the blades are touching to enable a close fit with the dilators. If blades are not aligned straight, check to make sure the frame arms are not angled. If the arms are angled, locate the angling nut in Step 12 and turn in the opposite direction until blades meet.

OBTAIN EXPOSURE:

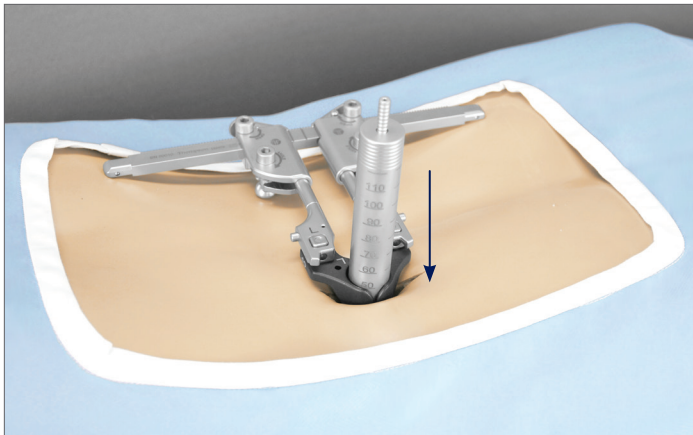

STEP 7

Slide the caudal/cephalad blades attached to the frame over the dilators and rotate the frame so that the frame rack runs parallel to the spine.

TIP Hold blades together at the neck during insertion over dilators for the smoothest step transition.

TIP Point the rack away from the surgeon for a larger working area.



STEP 8

A Loosen the knurled knob on the distal end of the Articulating Arm.

B Loosen the black knob (knob shown in step 9B) on the Articulating Arm and pull the distal end of the arm toward the frame rack. Unlock the cam joint on the rail clamp if needed. Insert the distal end of the arm over the end of the frame rack.

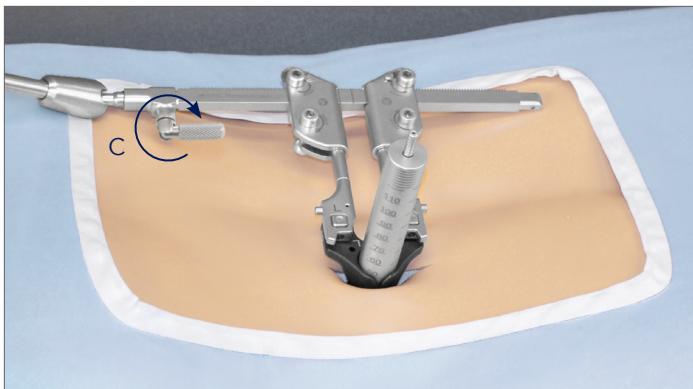

C Tighten the knurled knob on the distal end of the arm to lock the frame to the table mount.

TIP Use an assistant to hold the frame and blades steady while attaching to the table mount.

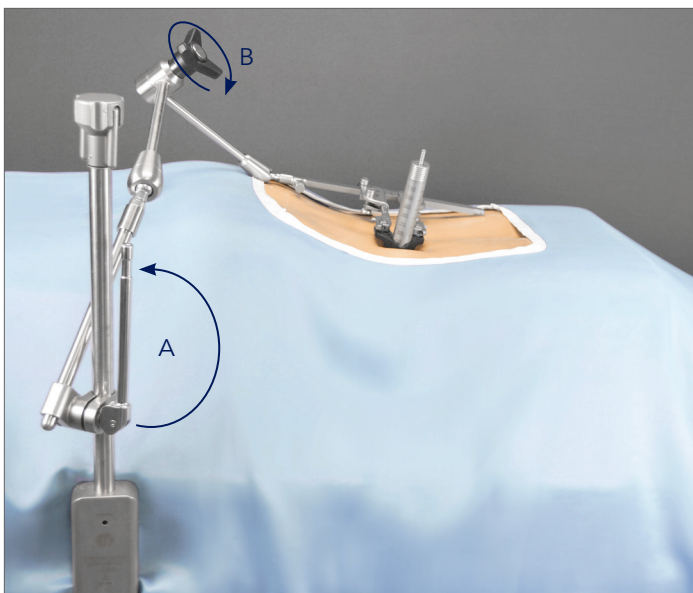

STEP 9

Hold frame in position while an assistant (**A**) locks the joint on the rail clamp then (**B**) tightens the black knob.

TIP If adjustments are needed, simply loosen the black knob to add flexibility to the arm. Reposition the frame and then re-tighten the black knob.

TIP Arch the section of the arm with the black knob upwards to add counter pressure to the frame and to allow for easy access to the knob if adjustments are needed.

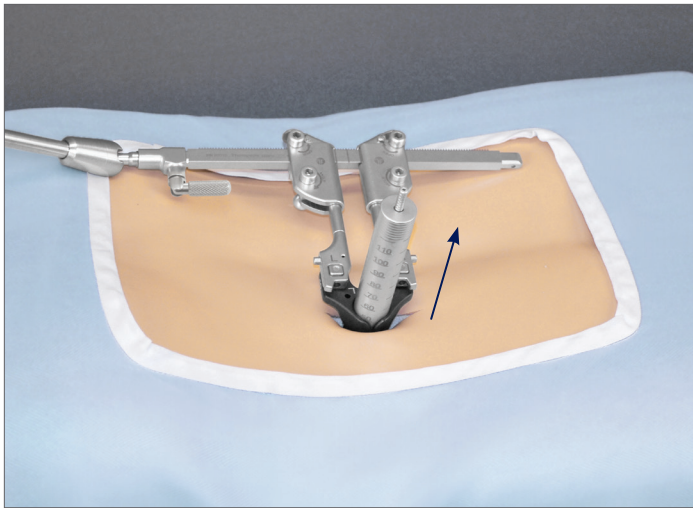

STEP 10

Remove the dilators in one step by pulling up on the initial dilator. Use caution handling dilators to avoid dropping.

TIP If friction occurs between the dilators and the blades, hold the frame in position as the dilators are removed to prevent the frame from rising up.

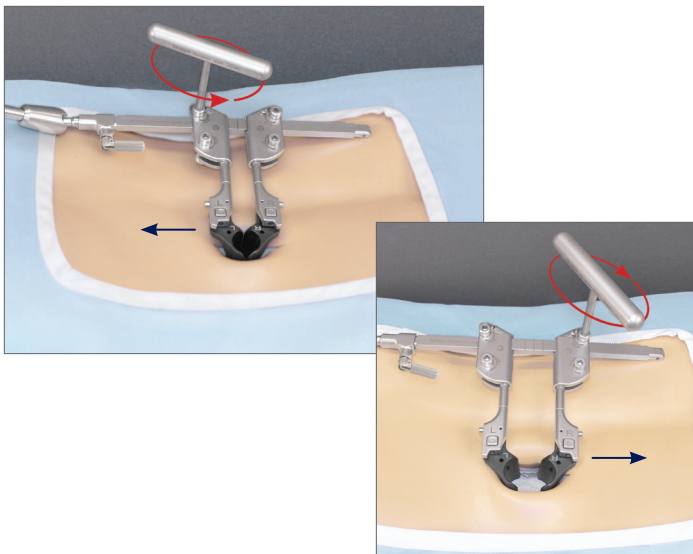

STEP 11

Retract blades independently to the desired exposure by turning the nut closest to the frame rack labeled "OPEN" using the T-Handle. To reverse retraction, press the pawl located on the frame arm as done in Step 6.

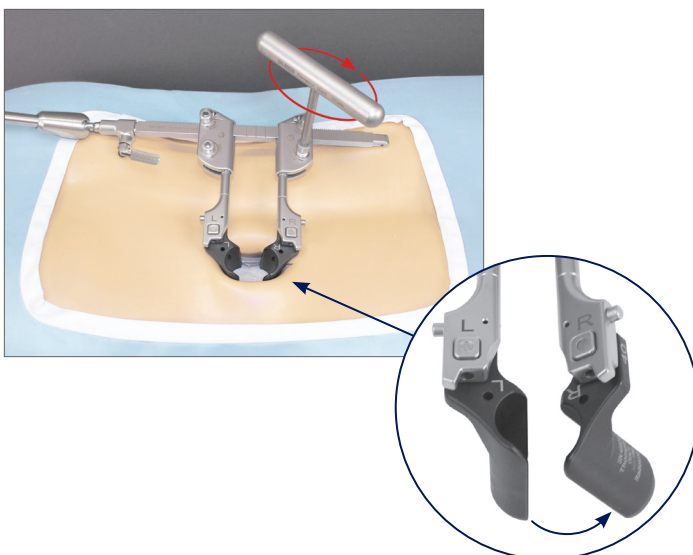

STEP 12

Angle blades independently to the desired exposure by turning the nut labeled "ANGLE" using the T-Handle. To reverse the angle, turn the T-Handle in the opposite direction.

ADDING MEDIAL/LATERAL RETRACTION:

STEP 13

To prevent muscle creep, medial and lateral blades or hooks may be added.

A If medial and lateral retraction is desired, place the L-Bar over the Frame Rack, outside of the Frame Arms and secure by turning the knob.

B To add a lateral retractor, place the U-Bar Add-on on to the L-Bar rack by pressing the pawl on the U-Bar Add-on.

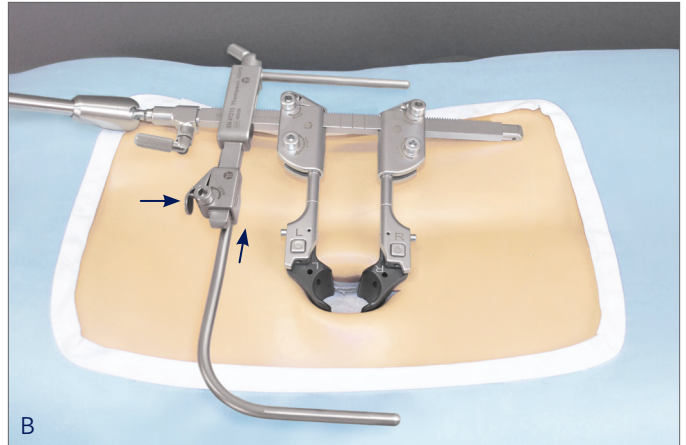

STEP 14

Select the desired blade style/s for retraction in the medial and/or lateral direction in a depth that is 10-20mm longer than the depth used for the caudal/cephalad blades.

A Insert the blade/s in to the S-Lock Quick Angle Handle/s by pressing the gold button on the handle (**B**).

In the first groove (1), the blade will be allowed to swivel. In the second groove (2), the blade will lock in position by mating with serrations on the handle.

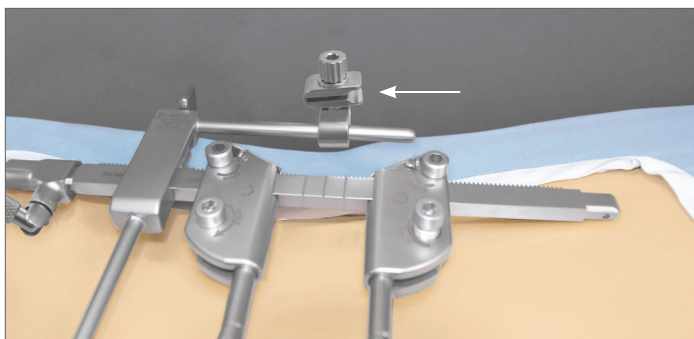

STEP 15

Slide the 1/4" x 1/4" Side Clip Slide joint over the end of the L-Bar with the clip side of the joint and the knob on top as shown.

TIP Do not allow joint to slide off of the U or L-Bar. Tighten slightly to prevent it from sliding but do not tighten all the way down.

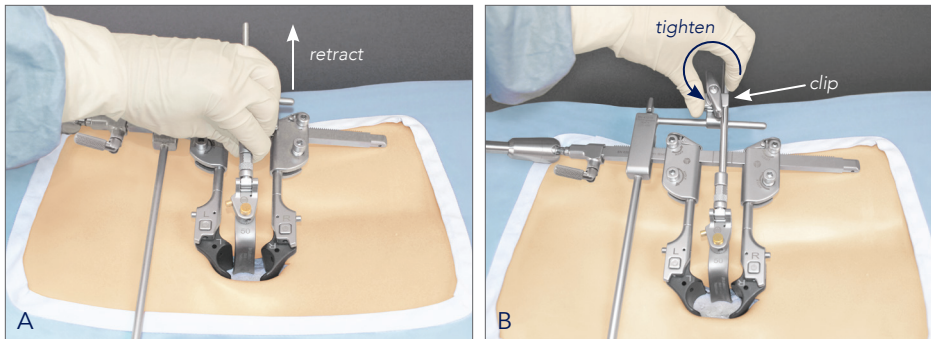

STEP 16

A Insert the medial/lateral blade into the incision and retract handle back by hand.

B Snap the handle into the clip joint and turn the knob with fingers or with T-Handle to tighten.

TIP If the handle does not easily snap in, the joint may need to be loosened first.

STEP 17

A To add a lateral retractor, attach the desired blade to the S-Lock Interchangeable Head. Insert the blade in to the incision and retract towards the U-Bar.

B Snap the S-Lock Interchangeable Head on to the U-Bar. If it does not easily snap on, joint may need to be loosened with fingers or T-Handle. To lock, use the T-Handle to tighten the joint.

C To retract the lateral blade, apply the T-handle to the U-Bar where it attaches to the L-Bar.

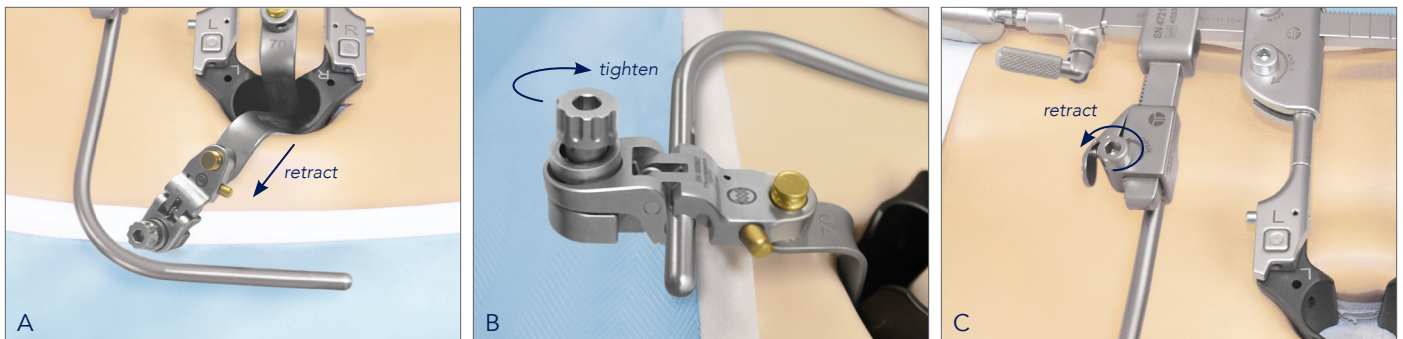

STEP 18

To angle medial/lateral blades, use fingers to rotate the knob on the handle or, if additional leverage is needed, insert the T-Handle into the top knob.

REMOVAL:

To remove the retractor, begin by returning all blades to a straight up and down position by unangling all blades. Next, remove the medial and lateral retractors by loosening the joints, removing handles and blades, and sliding them off of the U or L-Bar. Carefully, return the caudal/cephalad blades to the start position by pressing the pawl so that the blades can be pushed together. Dismount the Articulating Arm from the frame and gently pull the frame and blades up to remove from the patient.

For a Free Trial Call Today*
1.800.227.7543

Rev G
050224
plaum0517



Uncompromised Exposure
VISIT US ONLINE: THOMPSONRETRACTOR.COM

10341 East Cherry Bend Road
Traverse City, Michigan 49684
phone: 231.922.0177
fax: 231.922.0174
thompsonretractor.com

Emergo Europe
Westervoortsedijk 60
6827 AT Arnhem
THE NETHERLANDS

* Free trial valid for U.S. customers only. Customers outside U.S. please call +1-231-922-0177 for availability.

© 2024 Thompson Surgical Instruments, Inc. Printed in the U.S.A.

© S-Lock® and the "T Circle" logomark  are Registered Trademarks of Thompson Surgical Instruments, Inc.
Patents: trpat.com

Note: As we continually strive to provide the best products possible, some of the images in this document may appear slightly different from the product received.

 0297

Made In
USA